







13 714 705



- 160mm projection
- fixed spout
- rectangular spray pattern with 40 individual jets
- height of mixer 108 mm
- height up to aerator 94 mm
- hole diameter 35 mm
- 2x screw-in M 10 x 1 pressure hose, leak-tested
- 1/2" connection
- max. flow 4 l/min
- lead-free
- This product can help a building meet the requirements of Green Building Rating Systems, e.g. LEED®, BREEAM®, DGNB

	Brushed Dark Platinum	13 714 705-99
	Chrome	13 714 705-00
	Brushed Platinum	13 714 705-06
	Dark Chrome	13 714 705-19
	Brushed Champagne (22kt Gold)	13 714 705-46
	Champagne (22kt Gold)	13 714 705-47

13 714 705

mm [inches]

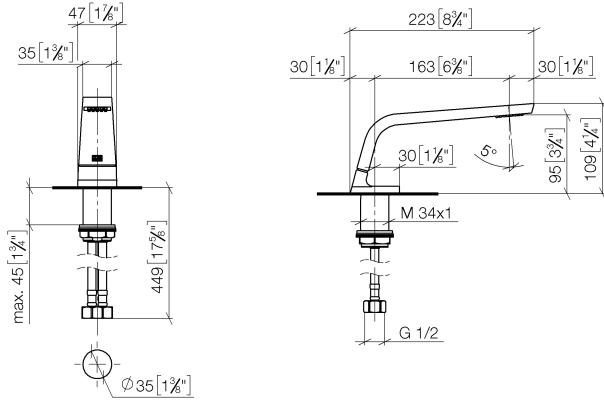

Flow rate chart



Codes & Standards

ASME
A112.18.1/CSA
B125.1

California Energy
Commission
(CEC)

NSF/ANSI 372

NSF/ANSI/CAN
61

Water Sense





CL.1 Deck-mounted basin spout without pop-up waste - Brushed Dark Platinum

CL.1

13 714 705

Certificates

GDV_0400279. LGA_28686. IAPMO_N-4976. IAPMO_8834 (1). WRAS_1512011.
IAPMO_4976 (4). IAPMO_6397.

13 714 705

Parts for other finishes can be found here: [Chrome](#)

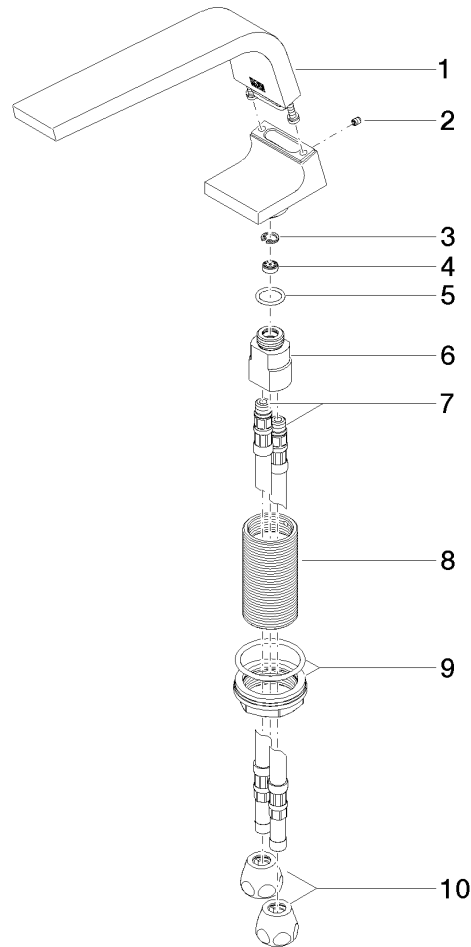

Spare parts list

No.	Item Number	Name	Quantity used	Delivery time
1	90 11 70 002 00-99	spout	1	30
2	09 31 11 044 90	pin	1	2
3	09 16 01 016 90	ring	1	2
4	09 23 01 034 90	flow reducer	1	2
5	09 14 10 130 90	seal	1	2
6	09 11 10 055 10 90	connection	1	2
7	04 30 04 016 00 90	hose	2	60
8	09 30 01 208 90	connection	1	2
9	04 23 10 044 06 90	fixing set	1	2
10	90 23 30 040 00-99	threaded connector	2	30